

SPECIFICATION (PRELIMINARY)

CTEZED 23.3 JH

S2



22,6 m*



7 / 10 m*



230 kg



20,6 m



1400x700x1100 mm

GVW min

3,5 t

WORKING ENVELOPE

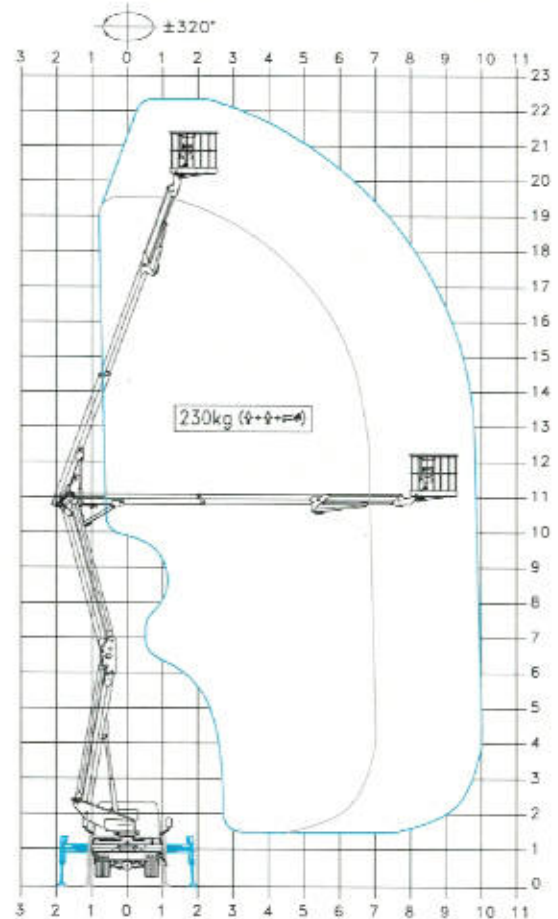

* outreach and height max values and repeatability can change within $\pm 3\%$ due to manufacturing variation and working condition.

OUTRIGGER FOOTPRINT

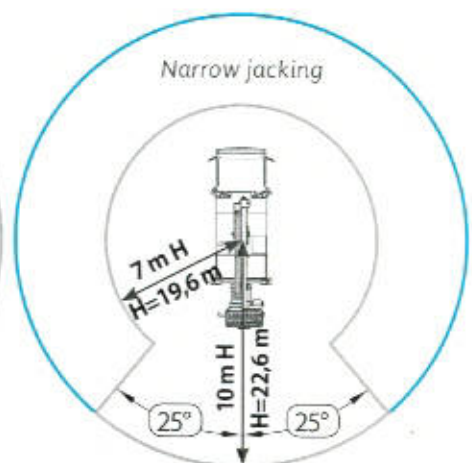
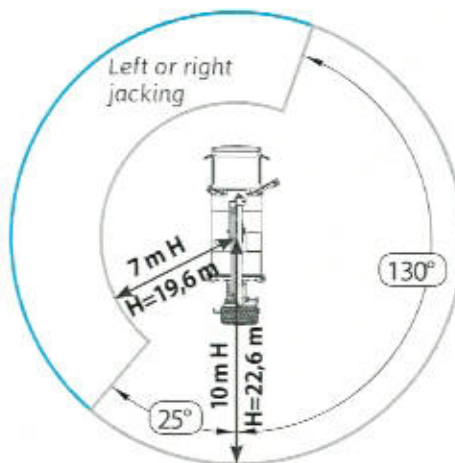
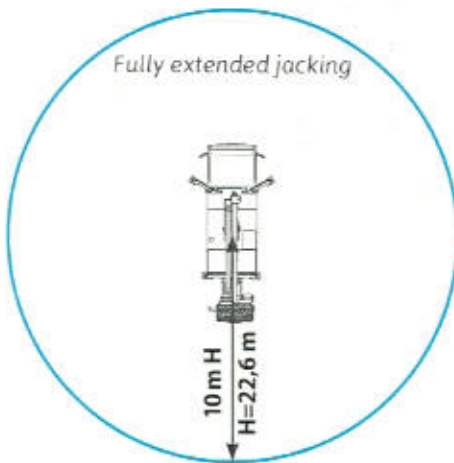

Product specifications are subject to change without notice or obligation. Technical features and drawings in this brochure are for illustrative purposes only. CTEZED 23.3 JH - ed. 2/17



CTE S.p.A.

Headquarter 7 Via Caproni - Rovereto (TN) IT, 38068

Ph. +39 0464 48.50.50 - Fax +39 0464 48.50.99

info@ctelift.com - www.ctelift.com

Factory 5 Loc. Terramatta - Rivoli Veronese (VR) IT, 37010

Warehouse 2 Via E. Fermi - Affi (VR) IT, 37010

CTE UK Ltd Enderby Leicestershire - UK

